

Trim for Swinging Patio Doors

**MULTI POINT LOCK TRIM**

2011 Price Book



## HAND OF DOOR IS ALWAYS DETERMINED FROM THE OUTSIDE

Determining handing for door hardware is a different than determining handing for carpentry (ordering and hanging doors). If you follow the standard carpentry rules for handing door hardware, instead of following the diagram below, there is good chance you may end up with a lock that is handed incorrectly. Please refer to the diagram below and if you have any questions, call Customer Service at (800) 356-2741.

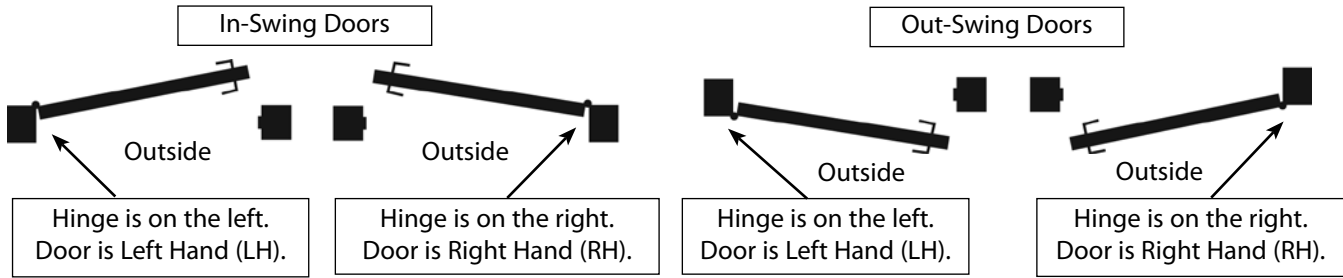

## FINISHES

- US7 - French Antique
- US10B - Oil Rubbed Bronze
- US15 - Satin Nickel
- US15A - Pewter
- US26 - Polished Chrome
- PVD-Lifetime
- DB - Deep Burgundy
- FB - Flat Black
- MB - Medium Bronze
- SP - Silver Patina
- SS - Stainless Steel

## PRODUCT CODE FORMAT

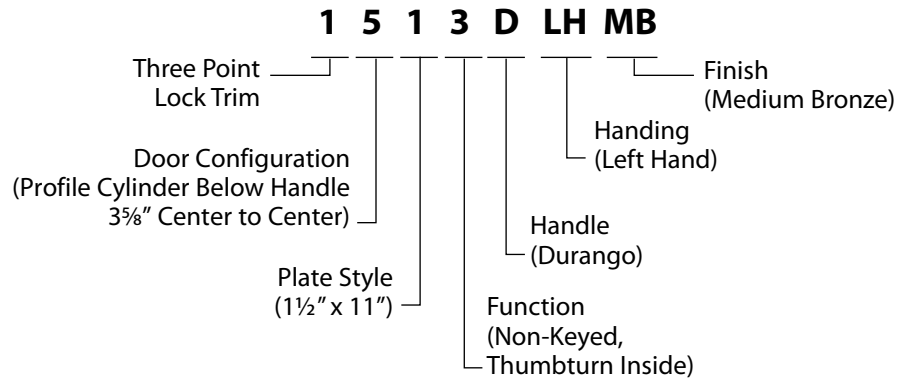

## TERMS AND CONDITIONS OF SALE

### Terms:

Net 30 Days on established credit.

### Shipping:

EMTEK builds all products to order and ships most orders within 48 hours. EMTEK pays the freight on all orders using 3 Day shipping service. To shorten the transit time, shipments can be upgraded to 2nd Day service or Next Day service for a fee. All shipping services are from the time the order is shipped.

### Returned Goods:

Merchandise may be returned only with approval from the factory. A copy of the factory issued RGA must accompany all returns. All returns must be sent freight prepaid. Returned goods are subject to a minimum 25% handling charge. Factory issued RGA's expire 90 days from the date they are issued.

### Minimum Order:

There is no minimum order quantity. A \$10.00 net handling charge will be added to orders valued at less than \$50.00 net.

### Patina Finishes:

Sandcast & Lost Wax Cast Bronze products have patina finishes that will gracefully age showing highlights of the underlying bronze over time.

### Prices:

Prices are subject to change without prior notice.

### Warranty:

See the last page of this booklet for warranty information.

# Emtek® Decorative Hardware

Emtek is a registered trademark of Emtek Products, Inc.

## Trim for Swinging Patio Doors (Multi Point Lock Trim)

|   | <b>PAGE</b> |
|---|-------------|
| Door Configuration #1 .....   | 6-11        |
| American Cylinder Hub Below Handle, 3 <sup>5</sup> / <sub>8</sub> " Center to Center  |             |
| <i>ref. Atrium®, G-U®, KML by Andersen®, Marvin Integrity®, Paddock Lockmaster™, Superior®</i>  |             |
| Door Configuration #2 .....   | 12-17       |
| American Cylinder Hub Above Handle, 3 <sup>5</sup> / <sub>8</sub> " Center to Center  |             |
| <i>ref. BiltBest®, G-U®, Hurd® (Energy Saver)</i>   |             |
| Door Configuration #3 .....   | 18-23       |
| American Cylinder Hub Above Handle, 4 <sup>1</sup> / <sub>8</sub> " Center to Center  |             |
| <i>ref. Andersen®</i>   |             |
| Door Configuration #4 .....   | 24-29       |
| American Cylinder Hub Above Handle, 3 <sup>5</sup> / <sub>8</sub> " Center to Center  |             |
| <i>ref. Ashland®, Caradco®, Jeldwen® Customer Collection (formerly Pozzi®), Marvin®, Milgard®, PGT®, Weathershield®</i>   |             |
| Door Configuration #5 .....   | 30-35       |
| Euro Profile Cylinder Below Handle, 3 <sup>5</sup> / <sub>8</sub> " Center to Center  |             |
| <i>ref. Crestline®, Hoppe®, Hurd®, JELD-WEN®, KFV®, Kolbe &amp; Kolbe®, Lincoln®, Loewen®, Paddock Lockmaster™, Peachtree®, Premium Collection (formerly Norco®), Semco®, Sierra Pacific®, Signature®, Simpson®, Therma-Tru®, Vetter®, Willmar®, Windsor®, Weathershield®</i> |             |
| Door Configuration #6 .....   | 36-41       |
| American Cylinder Hub Below Handle, 3 <sup>5</sup> / <sub>8</sub> " Center to Center  |             |
| <i>ref. Pella®</i>  |             |
| Door Configuration #7 .....   | 42-46       |
| American Cylinder Hub Above Handle, 6" Center to Center   |             |
| for doors made by W&F MANUFACTURING® (AKA Trillanium®)  |             |

---

### Disclaimer:

Door Manufacturers listed under each configuration are for reference only and are subject to change. Some retro fitting may be necessary. Please contact Emtek's customer service department to confirm product model.

---

G-U® is a registered trademark of G-U Hardware, Inc. Paddock™ is a registered trademark of Paddock Fabrications, LTD. Pella® is a registered trademark of Pella Corporation. Sierra Pacific Windows® is a registered trademark of Sierra Pacific Industries. Superior® is a registered trademark of Superior Engineered Products Corporation. Willmar® is a registered trademark of JELD-WEN of Canada Ltd. Andersen® is a registered trademark of Andersen Corporation. Trillanium® is a registered trademark of Trillanium. Eagle® is a registered trademark of Eagle Window and Door, Inc. BiltBest® is a registered trademark of BiltBest Windows and Patio Doors. Ashland® is a registered trademark of Ashland Products, Inc. Caradco®, JELD-WEN, Norco® and Pozzi® are registered trademarks of JELD-WEN Inc., Oregon, USA. Integrity® and Marvin® are registered trademarks of Marvin Windows and Doors. Milgard® is a registered trademark of Milgard Windows, Inc. Therma-Tru® is a registered trademark of Therma-Tru Doors®. HOPPE® is a registered trademark of HOPPE North America, Inc. Hurd® is a registered trademark of Hurd Millwork Company. Kolbe & Kolbe® is a registered trademark of Kolbe & Kolbe Millwork Company, Inc. Lincoln® is a registered trademark of Lincoln Wood Products, Inc. Loewen® is a registered trademark of Loewen Windows. PGT® is a registered trademark of PGT Industries. Peachtree® and Vetter® are registered trademark of The Peachtree Companies, Inc. Semco® is a registered trademark of Semling-Menke Co. Inc. Weathershield® is a registered trademark of Weathershield Mfg. Inc. KML by Andersen® is a registered trademark of KML by Andersen. Atrium® is a registered trademark of Atrium. KFV® is a registered trademark of KFV. Simpson® is a registered trademark of Simpson. Signature® is a registered trademark of Signature. Crestline® is a registered trademark of Crestline. Winsor® is a registered trademark of Winsor. W&F MANUFACTURING® is a registered trademark of W&F MANUFACTURING. *With the exception of Paddock™, none of the aforementioned companies are affiliated with Emtek Products, Inc.*

# Choose Trimsets For 7 Door & Lock Configurations

Both Keyed And Non-Keyed Functions Available For Each Configuration

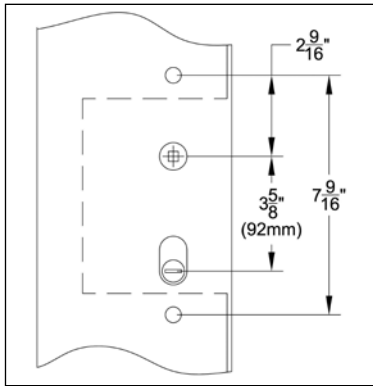

Door Configuration #1  
American Cylinder Below Handle  
3 5/8" Center to Center

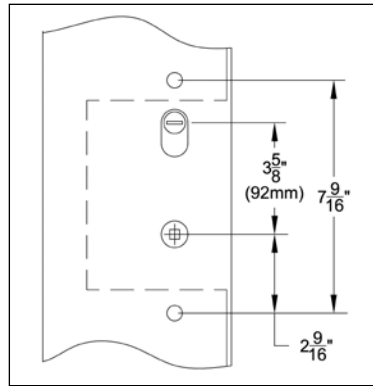

Door Configuration #2  
American Cylinder Above Handle  
3 5/8" Center to Center

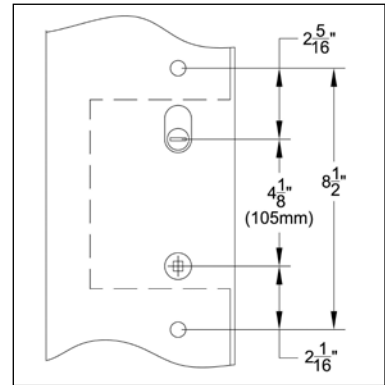

Door Configuration #3  
American Cylinder Above Handle  
4 1/8" Center to Center

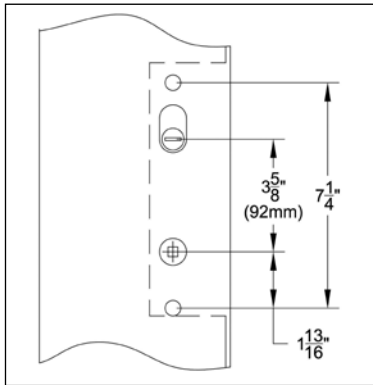

Door Configuration #4  
American Cylinder Above Handle  
3 5/8" Center to Center

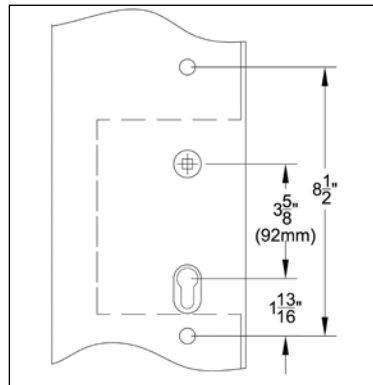

Door Configuration #5  
Euro Profile Cylinder Below Handle  
3 5/8" Center to Center

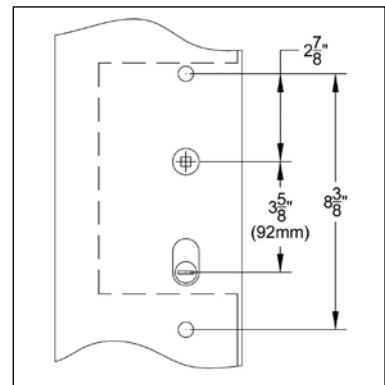

Door Configuration #6  
American Cylinder Below Handle  
3 5/8" Center to Center

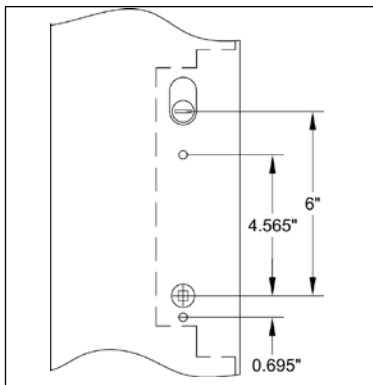

Door Configuration #7  
American Cylinder Hub Above Handle  
6" Center to Center

## >> To determine your Multi-Point Lock configuration:

- 1) Identify the manufacturer of your patio door and multi-point lock
- 2) Measure center-to-center hole spacing between lever and the cylinder
- 3) Check the lever position, is it above or below the cylinder?
- 4) Identify the type of cylinder used in the door, is it American or Euro Style Cylinder?

## Brass Lever Options



Aireon Lever (A)



Cortina Lever (C)



Elan Lever (EN)



Lafayette Brass Lever (LB)



Milano Lever (M)



Ribbon & Reed Lever (RBL)



Rope Lever (RL)



Rustic Lever (R)



Santa Fe Lever (SF)



Turino Lever (T)



Wembley Lever (WM)

## Brass Modern Lever Options



Athena Lever (ATN)



Basel Lever (BA)



Geneva Lever (GV)\*



Hercules Lever (HEC)



Hercules Black Leather Lever (HBK)



Hercules Brown Leather Lever (HBN)



Helios Lever (HLO)



Hermes Lever (HER)



Kiel Lever (KIE)



Luzern Lever (LU)



Mercury Lever (MC)



Poseidon Lever (POS)



Sion Lever (SIO)



Stuttgart Lever (STU)



Triton Lever (TRT)

*\* For Single Door Application Only.*

## Stainless Steel Lever Options



Achilles Lever (AC)



Ajax Lever (AJ)



Athena Lever (AT)



Cologne Lever (CO)



Dresden Lever (DD)



Hercules Lever (HS)



Hermes Lever (HE)



Kiel Lever (KL)



Poseidon Lever (PO)



Stuttgart Lever (ST)

## Sandcast Bronze Lever Options



Aurora Lever (AR)



Cimarron Lever (CR)



Cody Lever (CD)



Durango Lever (D)



Montrose Lever (MT)



Teton Lever (TT)

## Lost Wax Cast Bronze Lever Options



Art Nouveau Lever (ANL)



Dakota Black Leather Lever (BLKDK)



Dakota Brown Leather Lever (BRNDK)



Medici Lever (MDI)



Napoli Lever (NA)



Octagon Lever (OCL)



Padua Lever (PD)

# Door Configuration #7

W&F MANUFACTURING® (AKA Trillanium®)

## BRASS & STAINLESS STEEL TRIM AND CYLINDERS FOR MULTI POINT LOCKS

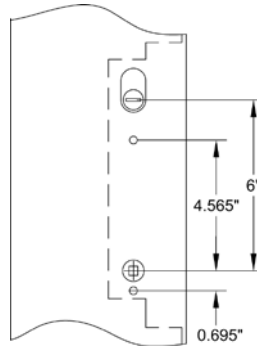

### Brass Plates, Modern Style

|   | Product Code | Lever Style (LH/RH)   | Finish   | List Price |
|---|--------------|---|--|------------|
| <b>Sets with 2" x 10" Plates</b>                                    |              | <i>See Page 5 for Brass &amp; Modern Brass Lever Options.</i> | Oil Rubbed Bronze (US10B)<br>Satin Nickel (US15)<br>Polished Chrome (US26) | \$00.00    |
| Keyed with American Cylinder<br><i>(Schlage® keyway, rekeyable)</i> | 17B1         |   |  |            |
| Non-Keyed <i>T-turn Inside (Patio Function)</i>                     | 17B3         |   |  |            |
| Dummy Pair  | 17B5         |   |  |            |
| Non-Keyed <i>American Style T-turn Inside, Fixed Handles</i>        | 17B6         |   |  |            |

### Stainless Steel Plates, Modern Style

|   | Product Code | Lever Style (LH/RH)  | Finish               | List Price |
|---|--------------|--|----------------------|------------|
| <b>Sets with 2" x 10" Plates</b>                                    |              | Ajax (AJ)<br>Achilles (AC)<br>Athena (AT)<br>Cologne(CO)<br>Dresden (DD)<br>Hercules (HS)<br>Hermes (HE)<br>Kiel (KL)<br>Poseidon (PO)<br>Stuttgart (ST) | Stainless Steel (SS) | \$00.00    |
| Keyed with American Cylinder<br><i>(Schlage® keyway, rekeyable)</i> | 17B1         |  |                      |            |
| Non-Keyed <i>T-turn Inside (Patio Function)</i>                     | 17B3         |  |                      |            |
| Dummy Pair  | 17B5         |  |                      |            |
| Non-Keyed <i>American Style T-turn Inside, Fixed Handles</i>        | 17B6         |  |                      |            |

*Swinging Patio Door Hardware - Set includes Plates, Handles and Cylinders (where applicable).*

**Handing required.** Key codes may be specified. Sets fit standard door thickness of 1¾", specify if different.

## SANDCAST BRONZE TRIM AND CYLINDERS FOR MULTI POINT LOCKS

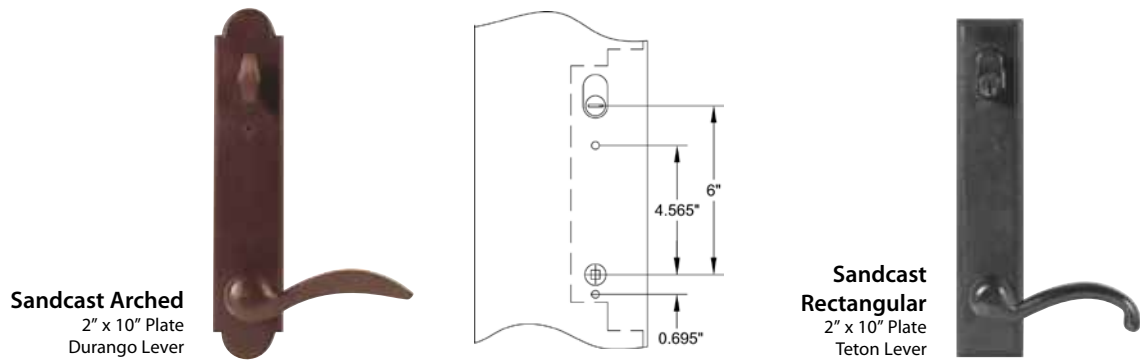

### Sandcast Bronze Plates, Arched Style

|   | Product Code | Lever Style (LH/RH)   | Finish  | List Price      |
|---|--------------|---|---|-----------------|
| <b>Sets with 2" x 10" Plates</b>                                    |              | Aurora (AR)<br>Cimarron (CR)<br>Cody (CD)<br>Durango (D)<br>Montrose (MT)<br>Teton (TT) | Deep Burgundy (DB)<br>Flat Black (FB)<br>Medium Bronze (MB)<br>Silver Patina (SP) | \$ <b>00.00</b> |
| Keyed with American Cylinder<br><i>(Schlage® keyway, rekeyable)</i> | 1721         |   |   |                 |
| Non-Keyed <i>T-turn Inside (Patio Function)</i>                     | 1723         |   |   |                 |
| Dummy Pair  | 1725         |   |   |                 |
| Non-Keyed <i>American Style T-turn Inside, Fixed Handles</i>        | 1726         |   |   |                 |

### Sandcast Bronze Plates, Rectangular Style

|   | Product Code | Lever Style (LH/RH)   | Finish  | List Price      |
|---|--------------|---|---|-----------------|
| <b>Sets with 2" x 10" Plates</b>                                    |              | Aurora (AR)<br>Cimarron (CR)<br>Cody (CD)<br>Durango (D)<br>Montrose (MT)<br>Teton (TT) | Deep Burgundy (DB)<br>Flat Black (FB)<br>Medium Bronze (MB)<br>Silver Patina (SP) | \$ <b>00.00</b> |
| Keyed with American Cylinder<br><i>(Schlage® keyway, rekeyable)</i> | 1761         |   |   |                 |
| Non-Keyed <i>T-turn Inside (Patio Function)</i>                     | 1763         |   |   |                 |
| Dummy Pair  | 1765         |   |   |                 |
| Non-Keyed <i>American Style T-turn Inside, Fixed Handles</i>        | 1766         |   |   |                 |

*Swinging Patio Door Hardware - Set includes Plates, Handles and Cylinders (where applicable).*

**Handing required.** Key codes may be specified. Sets fit standard door thickness of 1¾", specify if different.

# Door Configuration #7

W&F MANUFACTURING® (AKA Trillanium®)

## LOST WAX CAST BRONZE TRIM AND CYLINDERS FOR MULTI POINT LOCKS



**Bronze Tuscany**  
2" x 10" Plate  
Medici Lever

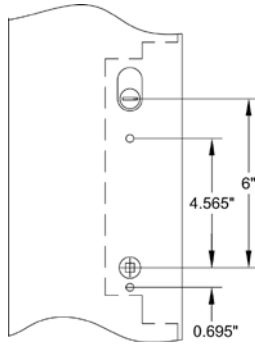

**Bronze Tuscany**  
2" x 10" Plate  
Napoli Lever

### Lost Wax Cast Bronze Plates, Tuscany Style

|   | Product Code | Lever Style (LH/RH)   | Finish  | List Price      |
|---|--------------|---|---|-----------------|
| <b>Sets with 2" x 10" Plates</b>                                    |              | Art Nouveau (ANL)<br>Dakota with<br>Black Leather (BLKDK)<br>Dakota with<br>Brown Leather (BRNDK) | Deep Burgundy (DB)<br>Flat Black (FB)<br>Medium Bronze (MB)<br>Silver Patina (SP) | \$ <b>00.00</b> |
| Keyed with American Cylinder<br><i>(Schlage® keyway, rekeyable)</i> | 1741         |   |   |                 |
| Non-Keyed <i>T-turn Inside (Patio Function)</i>                     | 1743         | Medici (MDI)<br>Napoli (NA)<br>Octagon (OCL)<br>Padua (PD)  |   |                 |
| Dummy Pair  | 1745         |   |   |                 |
| Non-Keyed <i>American Style T-turn Inside, Fixed Handles</i>        | 1746         |   |   |                 |

*Swinging Patio Door Hardware - Set includes Plates, Handles and Cylinders (where applicable).*

**Handing required.** Key codes may be specified. Sets fit standard door thickness of 1¾", specify if different.

## Door Configuration #7 American Cylinder Above Handle 6" Center to Center

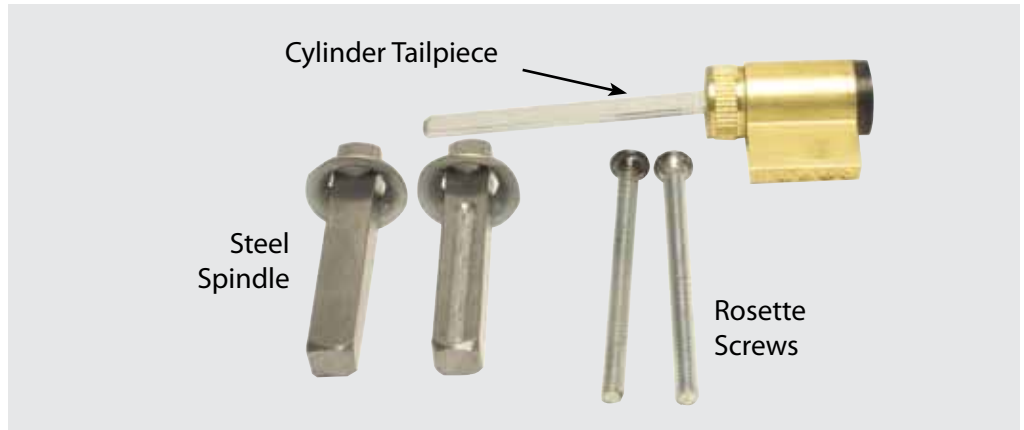
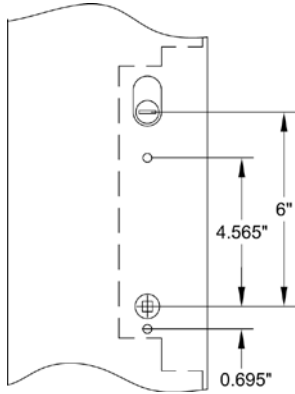

### Keyed Plates with American Cylinder *Includes non-keyed, thumbturn inside*

|  |   |
|--|---|
| Standard Door Thickness: 1 $\frac{5}{8}$ " - 2"  | Extended Door Thickness: 2 $\frac{1}{8}$ " - 2 $\frac{3}{4}$ "  |
| Standard Components: <ul style="list-style-type: none"> <li>• Single Cylinder Tailpiece</li> <li>• 2" Steel Spindles</li> <li>• 2" Rosette Screws</li> </ul> | Extended Components: <ul style="list-style-type: none"> <li>• Long Single Cylinder Tailpiece</li> <li>• 2" Steel Spindle</li> <li>• 2 <math>\frac{1}{2}</math>" Rosette Screws</li> </ul> |

### Non-Keyed Plates *Includes non-keyed passage, fixed handle out/operating handle in, & dummy (uses screws only)*

|  |  |
|--|--|
| Standard Door Thickness: 1 $\frac{5}{8}$ " - 2"  | Extended Door Thickness: 2 $\frac{1}{8}$ " - 2 $\frac{3}{4}$ "   |
| Standard Components: <ul style="list-style-type: none"> <li>• Single Cylinder Tailpiece</li> <li>• 2" Steel Spindle (Handle out/operating handle in)</li> <li>• 2" Rosette Screws</li> </ul> | Extended Components: <ul style="list-style-type: none"> <li>• Long Single Cylinder Tailpiece</li> <li>• 2" Steel Spindle (Handle out/operating handle in)</li> <li>• 2 <math>\frac{1}{2}</math>" Rosette Screws</li> </ul> |

## CONSTRUCTION KEYING

- Lost ball system.
- Last four pin locations drilled for lost ball application.
- Master key wafers used for code variability.
- Construction keys and owner keys sent separately.
- Order by indicating "**Construction Keyed, House #\_**" next to applicable locks.

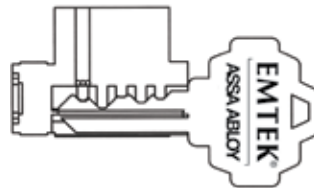

Construction devices used on one or all of last four positions.



Dimples drilled in plug in this position.

|  |
|--|
| <b>Charge for Construction Keying - \$4.00 per Cylinder (List)</b>   |
| • Locks that are both construction keyed and keyed alike in a house group will be charged a total of \$8.00 (list) per cylinder. |

|  |
|--|
| <b>Charge for Re-Keying - \$4.00 per Cylinder (List)</b>   |
| • Locks that are keyed to code or keyed alike in a house group will be charged \$4.00 (list) per cylinder. |

|  |
|--|
| <b>Keying to Code</b>  |
| • Order by indicating " Key Code XXXXX " next to applicable locks. |

|   |
|---|
| <b>Keying Alike</b>   |
| • Order by indicating " Keyed Alike" next to applicable locks if only one keyed alike group is wanted.    |
| • If ordering multiple groups (houses) indicate " <b>Keyed Alike House #_</b> " next to applicable locks. |

# Door Configuration #7 Specification Sheet

Trim & Cylinders for Multi Point Locks

Swinging Patio Door Hardware - Set includes Plates, Handles and Cylinders (where applicable)  
W&F MANUFACTURING® (AKA Trillenium®)

## Keyed with American Cylinder (for Active Door, Schlage Keyway, Rekeyable)

2" x 10" Plates, Product Codes 1721, 1741, 1761, 17B1

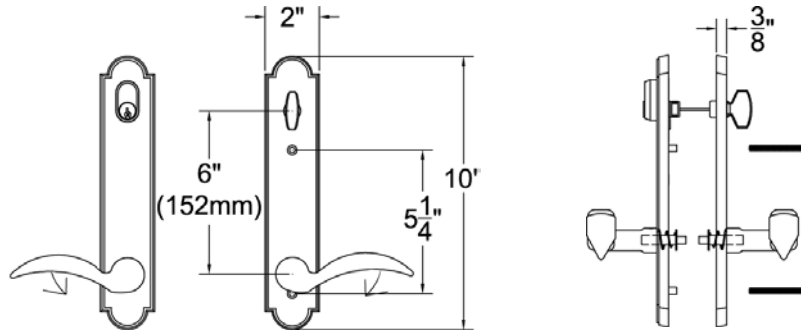

## Non-Keyed, American Style T-Turn Inside (Active Door)

2" x 10" Plates, Product Codes 1723, 1743, 1763, 17B3

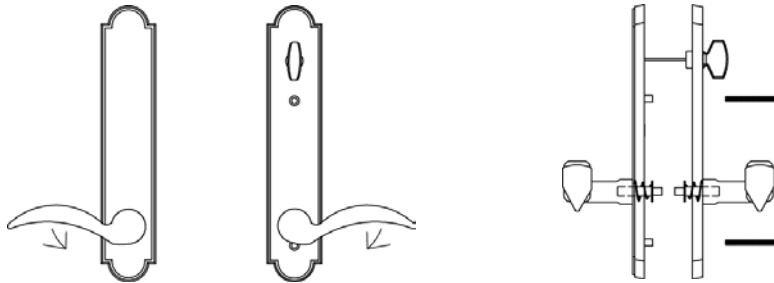

## Dummy Pair (for Non-Active Door)

2" x 10" Plates, Product Codes 1725, 1745, 1765, 17B5

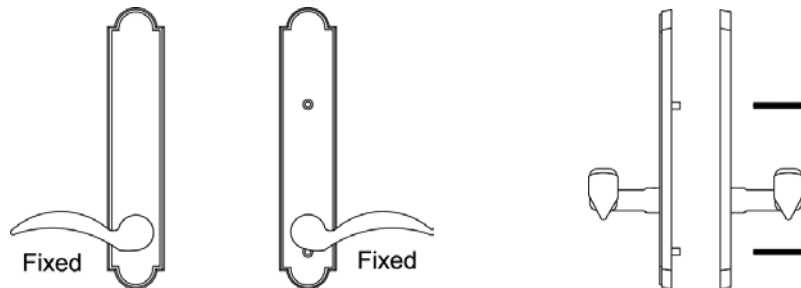

## Non-Keyed, Fixed Handles, American Style T-Turn Inside (for Semi-Active Door)

2" x 10" Plates, Product Codes 1726, 1746, 1766, 17B6

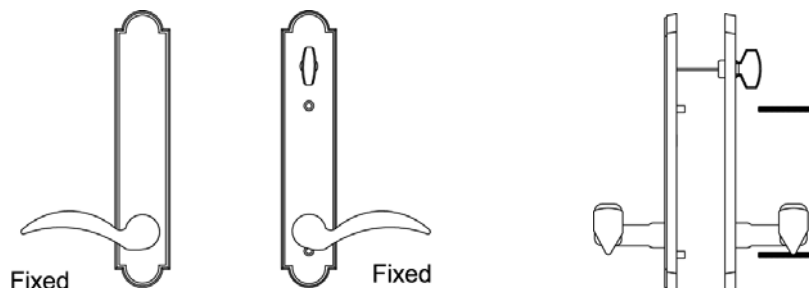

**DATE:** \_\_\_\_\_ **FROM:** ( include company name, address and customer number if possible )

**PO #:** \_\_\_\_\_

| Quantity | Product/Rosette Code | Backset | Handle Style | Handing<br><i>(When required, see below)</i> | Door Thickness | Finish | Price | Extension |
|----------|----------------------|---------|--------------|--|----------------|--------|-------|-----------|
|          |                      |         |              |  |                |        |       |           |
|          |                      |         |              |  |                |        |       |           |
|          |                      |         |              |  |                |        |       |           |
|          |                      |         |              |  |                |        |       |           |
|          |                      |         |              |  |                |        |       |           |
|          |                      |         |              |  |                |        |       |           |
|          |                      |         |              |  |                |        |       |           |
|          |                      |         |              |  |                |        |       |           |

**LIMITED WARRANTY**

EMTEK Products, Inc. (the "Company") warrants to the original purchaser that, except for products with Rust, Deep Burgundy, Medium Bronze, Flat Black Patina and Silver Patina finishes, the products manufactured by it (the "Products") are free of defects in material and workmanship, provided:

1. the Company has been notified within five years of purchase date and has been given the opportunity of inspection by return of any alleged defective Products to the Company, free and clear of all liens and encumbrances, transportation prepaid, accompanied by a statement of defects and proof of purchase; and
2. the Product has not been modified, abused, misused or improperly installed, maintained and/or repaired during such period; and

There is no warranty on Rust, Deep Burgundy, Medium Bronze, Flat Black Patina and Silver Patina finishes.

The Company shall, at its option, either repair or replace, free of charge, any Products or part thereof found upon the Company's inspection, to be so defective, or at the Company's sole discretion refund the purchase price, less a reasonable allowance for depreciation, in exchange for the Product.

**The Company makes no other warranty, and all implied warranties including any warranty of merchantability or fitness for a particular purpose are limited to the duration of the expressed warranty period as set forth above.**

**The Company's maximum liability hereunder is limited to the purchase price of the product. In no event shall the Company be liable for any consequential, indirect, incidental or special damages of any nature arising from the sale or use of the product, whether in contract, tort, strict liability or otherwise.**

Notes:

- A. Some states do not allow limitations on incidental consequential damages or how long an implied warranty lasts so that the above limitations may not fully apply.
- B. This warranty gives specific legal rights and a buyer may also have other rights which may vary from state to state.
- C. For warranty service and shipping instructions contact EMTEK Products, Inc. at:  
15250 E. Stafford Street, City of Industry, CA 91744, (626)961-0413.



EMTEK Products, Inc.  
15250 E. Stafford Street  
City of Industry • CA 91744  
Tel: 800-356-2741 • 626-961-0413  
Fax: 800-577-5771 • 626-336-2812  
[www.emtek.com](http://www.emtek.com)

BX4-BROCHURE2  
JUNE 2011